



LS7+ 72V35Ah

Official site: www.nanrobot.com
Contact & Support email :support@nanrobot.com

THIS MANUAL CONTAINS IMPORTANT INFORMATION TO HELP YOU USE YOUR PRODUCT MORE SAFELY.

PACKING LIST

CHECK THE FOLLOWING PARTS OF THE PRODUCT AFTER UNBOXING

1. PLEASE CHECK IF THERE IS A CHARGER.
2. PLEASE CHECK IF THERE IS A EXTENDED AIR INFLATOR TUBE.
3. PLEASE CHECK IF THERE IS A TOOL KIT.
4. PLEASE CHECK IF THERE ARE TWO NFCs.
5. PLEASE CHECK IF THERE IS A WIRELESS REMOTE CONTROL FOR LIGHT.
6. PLEASE CHECK IF THERE IS A MANUAL.
7. ALL NUTS AND SCREWS SHOULD BE TIGHT.
8. SEAT (IF AVAILABLE).
9. TEST THE BRAKES.



01



REQUIRED CHECK BEFORE RIDING

1. CHECK THAT THE CONTROL PANEL TURNS ON.
2. ENSURE THAT THE BRAKES ARE WORKING PROPERLY.
3. CHECK THAT THE BRAKE PADS ARE NOT DAMAGED OR NEED REPLACING.
4. MAKE SURE THE SEAT IS STABLE AND SECURE (IF AVAILABLE).
5. CHECK THAT THE HORN IS OPERATING CORRECTLY.
6. MAKE SURE THE VOLTAGE VALUE IS WITHIN THE NORMAL RANGE OF 63-84V.
7. MAKE SURE THE FOLDING MECHANISM IS IN GOOD CONDITION AND OPERATIONAL.
8. PRLONGED EXPOSURE TO UV RAYS, RAIN AND THE ELEMENTS MAY DAMAGE THE ENCLOSURE MATERIALS,STORE INDOORS WHEN NOT IN USE.
9. WARNING-TO REDUCE THE RISK OF INJURY, USER MUST READ INSTRUCTION MANUAL.
- 10.WARNING - DAMAGE CAUSED BY NATURAL DISASTERS SUCH AS ELECTRIC SHOCK, FIRE, FLOOD ARE NOT COVERED UNDER THE WARRANTY SERVICE.
- 11.AVERTISSEMENT - LES DOMMAGES CAUSÉS PAR DES CATASTROPHES NATURELLES TELLES QU'UNE DÉCHARGE ÉLECTRIQUE, UN INCENDIE OU UNE INONDATION NE SONT PAS COUVERTS PAR LE SERVICE DE GARANTIE.

PLEASE READ THIS MANUAL CAREFULLY BEFORE USING THE PRODUCT.

SAFETY PRECAUTIONS

1. ALWAYS WEAR A HELMET AND KNEE AND ELBOW PADS WHEN RIDING.
2. WHEN INITIALLY RIDING THE SCOOTER, MAINTAIN A LOW SPEED AND GRADUALLY INCREASE SPEED AS RIDING SKILLS IMPROVE.
3. DO NOT RIDE IN THE RAIN, IN THE SNOW, OR ON ROADS THAT ARE WET, MUDDY, ICY, OR THAT ARE SLIPPERY FOR ANY REASON.
4. RIDERS UNDER THE AGE OF 18 YEARS OLD SHOULD RIDE UNDER ADULT SUPERVISION.
5. ADJUST THE HANDLEBAR TO A SUITABLE AND COMFORTABLE POSITION.
6. WHEN GOING DOWNHILL, ENSURE YOU ARE DRIVING SLOWLY TO PREVENT ACCIDENTS.
7. PLEASE ADHERE TO ALL APPLICABLE LOCAL LAWS AND REGULATIONS WHILE USING THIS SCOOTER. DO NOT RIDE WHERE PROHIBITED BY LOCAL LAWS.
8. MAKE SURE ALL SCREWS ARE IN GOOD CONDITION AND PROPERLY FASTENED.
9. CHARGING INSTRUCTIONS - USE ONLY THE SPECIFIED CHARGER AS INSTRUCTED.
10. THE SLOPE FOR RIDING: $< 30^{\circ}$.
11. STORE THE SCOOTER IN A COOL, DRY, AND WELL-VENTILATED PLACE WHEN NOT IN USE.

PRODUCT SPECIFICATIONS

NANROBOT LS7_72V	
TIRE	11 INCH OFF-ROAD TIRES
LITHIUM BATTERY	72V35AH
MOTOR	3000W*2
RANGE	130 KM (SINGLE DRIVE, 75KG LOAD, 25KM/H FLAT ROAD RIDE AT CONSTANT SPEED, FULLY CHARGED, ADEQUATE TIRE PRESSURE)
	60-70KM (DUAL DRIVE)
MAXIMUM SPEED	120 KMH
CHARGING TIME	8-12H(12 HOURS WITH 1 CHARGER,8H WITH 2 CHARGERS)
SIZE	56.3*27.6*53.5 IN
NET WEIGHT	117 LBS/53KG
LOAD CAPACITY	MAX 330LBS/150KG
LIGHT	TURN SIGNAL LIGHT FRONT LIGHT TAILLIGHT AMBIENT LIGHT
BRAKE TYPE	DUAL HYDRAULIC BRAKE (NUTT)
SHOCK ABSORBER	FRONT AND REAR
DAMPER	√
NFC	√

PLEASE READ THIS MANUAL CAREFULLY BEFORE USING THE PRODUCT.

PRODUCT COMPONENTS



PRODUCT COMPONENTS

SERIAL NUMBER	NAME	SERIAL NUMBER	NAME
1	CONTROL PANEL	14	FRONT LIGHT
2	FRONT BRAKE LEVER	15	CHARGING PORT
3	HEAD LIGHT BUTTON TURN SIGNAL LIGHT BUTTON HORN BUTTON	16	KICKSTAND
4	AMBIENT LIGHT BUTTON	17	REAR SHOCK ABSORBER
5	GRIP	18	REAR FENDER
6	REAR BRAKE LEVER	19	BRAKE CALIPER
7	FOLDING KNOB	20	BRAKE DISC
8	HEAD LIGHT	21	REAR MOTOR
9	FRONT SHOCK ABSORBER	22	TAILLIGHT TURN SIGNAL LIGHT
10	FRONT FENDER	23	AMBIENT LIGHT
11	BRAKE CALIPER	24	NFC
12	FRONT MOTOR	25	DAMPER
13	BRAKE DISC	26	REFLECTOR

IMPORTANT CHECKLIST



1.CHECK WHETHER THE LED CONTROL PANEL SCREWS AND THE BRAKE LEVER SCREWS ARE TIGHTENED.



2.MAKE SURE THE BRAKE LEVER SCREWS ARE TIGHTENED.



3.CHECK WHETHER THE AMBIENT LIGHT BUTTON SCREWS ARE TIGHTENED.

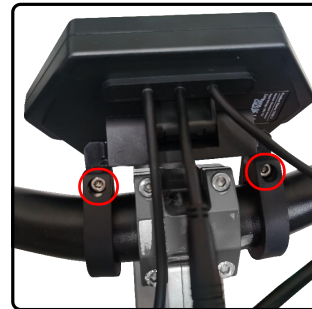

4.CHECK WHETHER THE BRACKET SCREWS ARE TIGHTENED.

HANDLEBAR ASSEMBLY



1. LOOSEN THE SCREWS ON THE HANDLE MOUNT WITH A 4MM HEX WRENCH, WHICH IS INCLUDED IN THE BASIC TOOL KIT.



2. AFTER ALIGNING THE HANDLEBAR WITH THE CENTER MOUNT, REPLACE THE COVER MOUNT, AND TIGHTEN THE FIXING BOLT.

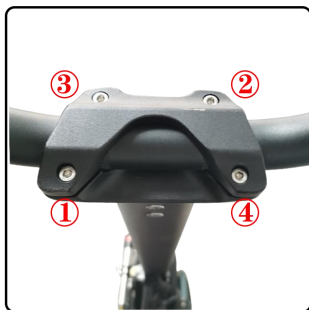

3. PROGRESSIVELY TIGHTEN THE BOLTS IN SEQUENTIAL ORDER (1 TO 4), ENSURING THERE IS EQUAL DISTANCE BETWEEN THE MOUNT AND HANDLEBAR ENDS.



4. INSTALLATION COMPLETE.

DAMPER ASSEMBLY

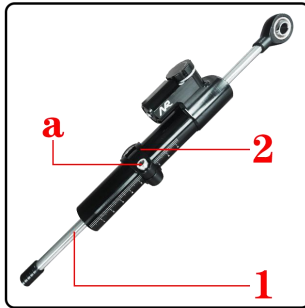
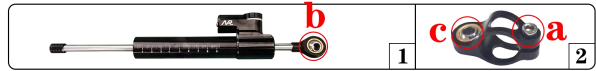

1. LOOSEN THE SCREWS "A" ON THE LOOP "2" WITH A HEX WRENCH, AND THEN PUT THE DAMPER "1" IN. DON'T TIGHTEN THE FIXING BOLT "A".



2. ALIGNING THE DAMPER WITH THE CENTER MOUNT, AND THEN TIGHTEN THE FIXING BOLT "B".

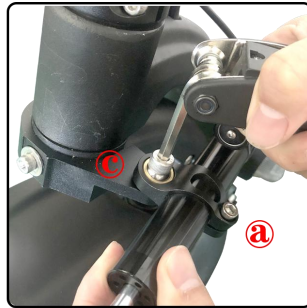

3. TIGHTEN THE FIXING BOLT "C". ALIGNING THE DAMPER WITH A SUITABLE SCALE LINE, AND THEN TIGHTEN THE FIXING BOLT "A".



4. INSTALLATION COMPLETE.

HANDLEBAR UNFOLDING



1. PULL THE HANDLEBAR IN THE DIRECTION INDICATED BY THE ARROW.

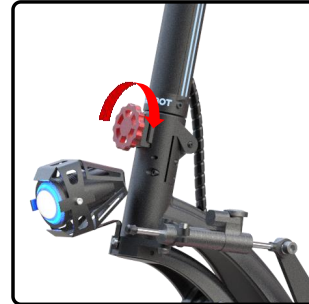

2. ALIGN THE]-SHAPED BUCKLE WITH THE GROOVES, THEN TIGHTEN THE FOLDING KNOB.



3. MAKE SURE TO PERFECTLY ALIGN THE]-SHAPED BUCKLE.



4. UNFOLDING COMPLETE.

HANDLEBAR FOLDING

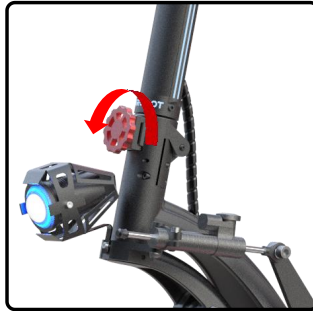

1. LOOSEN THE KNOB IN THE DIRECTION OF THE ARROW.



2. KEEP LOOSENING THE FOLDING KNOB UNTIL THE]-SHAPED BUCKLE COMPLETELY LEAVES THE GROOVES



3. LOWER THE HANDLEBAR.



4. FOLDING COMPLETE.

CHARGING & RANGE

CHARGING

WHEN CONNECTED TO THE CHARGER, THE RED LIGHT INDICATES THAT THE SCOOTER IS CHARGING. THE LIGHT WILL TURN GREEN WHEN FULLY CHARGED.

BE SURE TO CLOSE THE CHARGING PORT CAP WHEN DRIVING OR STORING EXCEPT WHEN CHARGING. USE ONLY GENUINE CHARGERS.

RANGE:

130 KM (SINGLE DRIVE, 75KG LOAD, 25KM/H FLAT ROAD RIDE AT CONSTANT SPEED, FULLY CHARGED, ADEQUATE TIRE PRESSURE). 60-70 KM (DUAL DRIVE).

THE RANGE OF THE SCOOTER DEPENDS ON MANY FACTORS: ROAD CONDITIONS (OFF-ROAD, UPHILL), WEATHER, RIDER'S BODYWEIGHT, FREQUENT BRAKING AND ACCELERATION, SINGLE/DUAL DRIVE, GEARS 1/2/3 ETC.

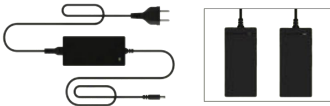

CHARGING INDICATOR

- CHARGING
- FULL CHARGED

CHARGING PORT



HANDLEBAR CONTROLS

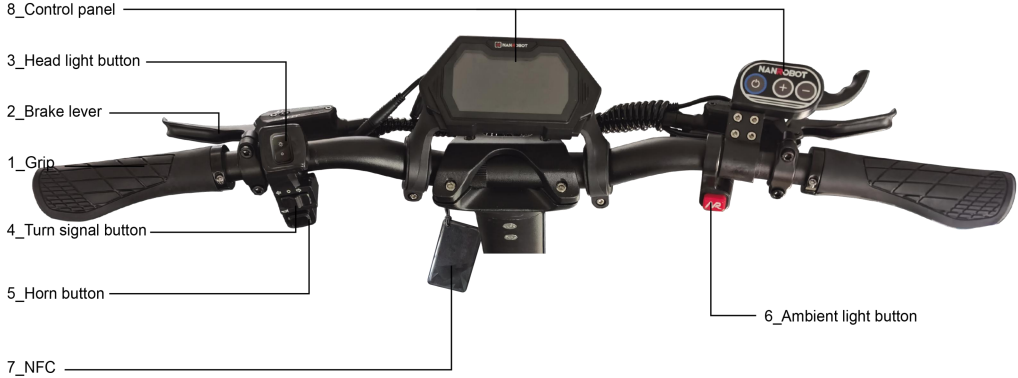

CONTROL PANEL INSTRUCTIONS



DISPLAY ALL THE CONTENTS OF THE METER

CONTROL PANEL INSTRUCTIONS

NUMBER	NAME	NUMBER	NAME
01	NFC SENSING AREA	10	MULTI-FUNCTION DISPLAY AREA
02	LEFT TURN SIGNAL	11	CURRENT UNIT
03	POWER	12	GEAR
04	VOLTAGE	13	BATTERY LEVEL
05	NON-ZERO START	14	UNIT OF SPEED
06	SINGLE DRIVE	15	BRAKE LIGHT
07	DUAL DRIVE	16	RIGHT TURN SIGNAL
08	SINGLE MILEAGE	17	HEAD LIGHT
09	TOTAL MILEAGE	18	CRUISE

DISPLAY ALL THE CONTENTS OF THE METER

CONTROL PANEL INSTRUCTIONS

POWER ON AND OFF

PRESS AND HOLD THE POWER SWITCH BUTTON TO POWER ON. AFTER STARTING UP, PUT THE CARD CLOSE TO THE CENTER OF THE METER (NFC SENSING AREA), AND THE METER WILL DISPLAY NORMALLY. PRESS AND HOLD THE POWER SWITCH BUTTON AGAIN, OR SWIPE THE CARD AGAIN TO TURN OFF. WHEN THE SCOOTER COMES TO A STOP FOR 20 SECONDS, THE DISPLAY WILL SWITCH TO P MODE. TO EXIT P MODE, SIMPLY PULL THE BRAKE LEVER. IF THE SCOOTER REMAINS IDLE AND NO OPERATION IS PERFORMED ON THE DISPLAY, IT WILL AUTOMATICALLY SHUT DOWN AFTER 5 MINUTES. PLEASE NOTE THAT FOR YOUR SAFETY, THE ELECTRIC SCOOTER WILL AUTOMATICALLY SWITCH TO THE P MODE WHENEVER IT IS TURNED ON. TO START DRIVING, PULL THE BRAKE LEVER.

KEY OPERATION

SHORT PRESS THE POWER SWITCH BUTTON TO SWITCH BETWEEN DISPLAYING SINGLE MILEAGE AND TOTAL MILEAGE. DOUBLE-CLICK THE POWER SWITCH BUTTON TO SWITCH BETWEEN DISPLAYING THE CURRENT VOLTAGE AND REAL-TIME POWER. SHORT PRESS THE POWER " + " BUTTON ON THE DIAL, THE GEAR WILL INCREASE. DOUBLE-CLICK THE POWER " + " KEY TO SWITCH BETWEEN SINGLE AND DUAL DRIVES, AND THE INSTRUMENT DISPLAY WILL SWITCH BETWEEN "SINGLE" (SINGLE DRIVE) AND "DUAL" (DUAL DRIVE). SHORT PRESS THE POWER " - " BUTTON, THE GEAR WILL DECREASE. DOUBLE-CLICK THE POWER " - " BUTTON, "SPEED" FLASHES, THE SCOOTER WILL LIMIT THE SPEED TO 25 KILOMETERS, AND REPEAT THE OPERATION TO RELEASE THE SPEED LIMIT.

19. POWER SWITCH BUTTON

20. POWER " + " BUTTON

21. POWER " - " BUTTON

22. ACCELERATION

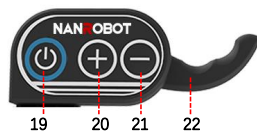

POWER TURN ON/OFF

- ① PRESS AND HOLD THE POWER BUTTON TO POWER ON
 - ② PUT THE CARD CLOSE TO THE CENTER OF THE METER (NFC SENSING AREA) ,TO GET A LIGHTUP SCREEN.
- IT IS IMPORTANT TO READ THIS INSTRUCTION BEFORE USING NFC FOR THE FIRST TIME.

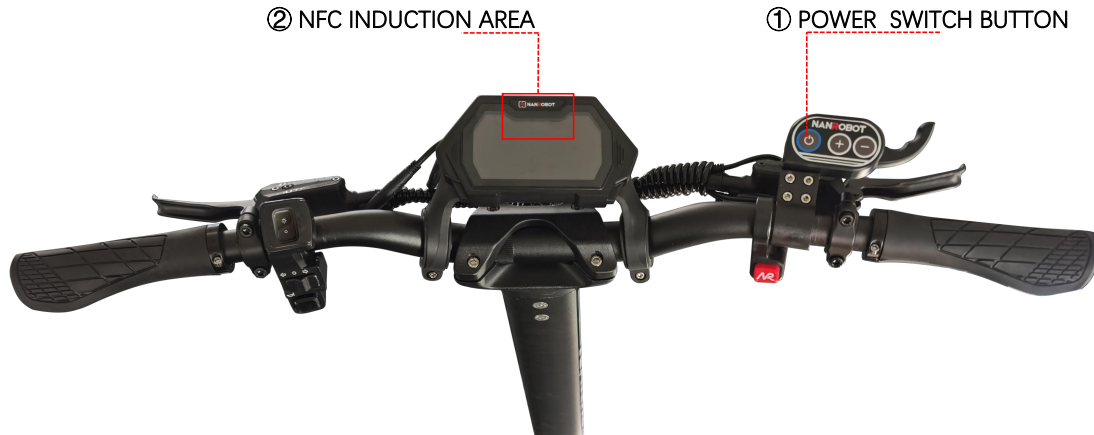

DEAR USERS, PLEASE READ THIS OPERATION MANUAL CAREFULLY BEFORE USING THE INSTRUMENT. THIS MANUAL WILL GUIDE YOU TO USE THE METER CORRECTLY.

ACCELERATION & BRAKE



DEAR USERS, PLEASE READ THIS OPERATION MANUAL CAREFULLY BEFORE USING THE INSTRUMENT. THIS MANUAL WILL GUIDE YOU TO USE THE METER CORRECTLY.

WIRELESS REMOTE CONTROL FOR LIGHT

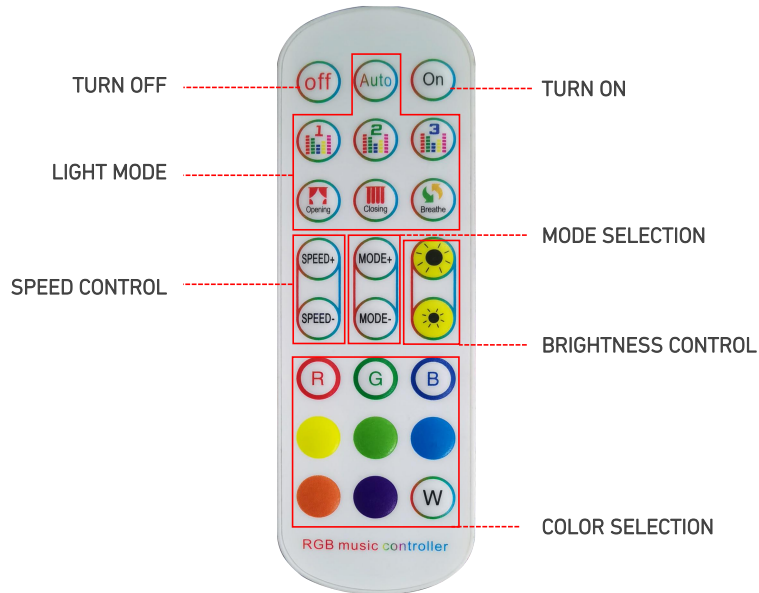

DEAR USERS, PLEASE READ THIS OPERATION MANUAL CAREFULLY BEFORE USING THE INSTRUMENT. THIS MANUAL WILL GUIDE YOU TO USE THE METER CORRECTLY.

PARAMETER SETTINGS

SET UP

IN THE NORMAL DISPLAY INTERFACE, PRESS AND HOLD THE + AND - KEYS AT THE SAME TIME, AND THE METER WILL ENTER THE SETTING INTERFACE. PRESS AND HOLD THE + AND - KEYS AGAIN ON THE SETTING INTERFACE TO SAVE THE PARAMETERS AND EXIT.

PARAMETER SETTINGS AND DESCRIPTION	
P0	WHEEL DIAMETER:5~24 (11 INCHES)
P1	VOLTAGE:(36V/48V/60V/72V)
P2	THE MOTOR MAGNETIC STEEL:10~50 (IF THE MOTOR MAGNETIC STEEL HAS 15 PAIRS OF POLES, THE PARAMETER SETTING: 30)
P3	SPEED SIGNAL:RESTORE FACTORY DEFAULTS. IN THIS INTERFACE, PRESS AND HOLD THE + BUTTON TO RESTORE THE FACTORY SETTINGS OF THE METER
P4	KM /MILES 0: KM. 1: MILES
P5	START MODE 0: NON-ZERO START 1: ZERO START
P6	CRUISE MODE 0: NON-CRUIISING. 1: CRUISE
P7	START 0:SLOW START 1:POWER START
P8	ADJUSTABLE SPEED LIMIT:10~100%
P9	FEBS(ELECTRIC BRAKE SYSTEM) BREAK SETTINGS:0~2 (0: WEAK EBS 1: NORMAL EBS 2: STRONGEST EBS)
EACH OPTION CAN BE ADJUSTED BY + KEY OR - KEY.	

COMMON PROBLEMS AND TROUBLESHOOTING METHODS

ERROR	CAUSES	SOLUTIONS
NO POWER	<ol style="list-style-type: none"> 1.BATTERY IS POORLY CONNECTED 2.BATTERY PROTECTION 	<ol style="list-style-type: none"> 1.CONNECT THE POWER CABLE APPROPRIATELY. 2. RECONNECT THE BATTERY CONNECTOR
MOTOR DOES NOT WORK WHEN THE POWER IS TURNED ON	<ol style="list-style-type: none"> 1.LOW BATTERY 2.BRAKE HANDLE DOES NOT REACH THE RIGHT POSITION 3.HANDLEBAR BREAK DOWN 4.THE CONTROLLER PLUG IS LOOSE 5.CONTROLLER BREAK DOWN" 	<ol style="list-style-type: none"> 1.CHARGE THE BATTERY 2. ADJUST THE BRAKE HANDLE TO THE RIGHT POSITION 3. REPLACE THE HANDLEBAR 4. RECONNECT THE CONTROLLER 5. REPLACE THE CONTROLLER
SPEED IS SLOW OR MILEAGE IS SHORT	<ol style="list-style-type: none"> 1.LOW BATTERY 2. FLAT TIRE 3. EXCESSIVE OVERLOAD 4.BRAKE PADS NEED TO BE CHANGED 5.BATTERY AGING OR BEING SCRAPPED NORMALLY 	<ol style="list-style-type: none"> 1.CHARGE THE BATTERY 2. INFLATE THE TIRES TO NORMAL TIRE PRESSURE 3. PLEASE DO NOT OVERLOAD 4. REPLACE THE BRAKE PADS ON TIME AND CHECK THE BRAKE SYSTEM BEFORE RIDING 5.CHANGE THE BATTERY
THE BATTERY IS UNABLE TO CHARGE	<ol style="list-style-type: none"> 1. POOR CONNECTION OF THE CHARGER PLUG 2. IMPROPER USE OF THE CHARGER 3.BATTERY AGING OR BEING SCRAPPED NORMALLY 	<ol style="list-style-type: none"> 1. CHECK IF THE POSITION OF THE CHARGER PLUG IS CORRECT 2.CHANGE THE BATTERY

COMMON PROBLEMS AND TROUBLESHOOTING METHODS

ERROR	CAUSES	SOLUTIONS
ERR1	THROTTLE FAILURE	PLEASE CONTACT WITH AFTER-SALE SERVICES
ERR2	MOTOR TEMPERATURE OVERHEAT	PARK IN A SHADED AREA FOR A WHILE
ERR3	LOW BATTERY FAILURE	CHARGE THE SCOOTER IN TIME
ERR4	MAIN CONTROLLER FAILURE	PLEASE CONTACT WITH AFTER-SALE SERVICES
ERR5	REAR MOTOR'S HALL FAILURE	PLEASE CONTACT WITH AFTER-SALE SERVICES
ERR6	DISPLAY COMMUNICATION FAILURE	PLEASE CONTACT WITH AFTER-SALE SERVICES
ERR7	CONTROLLER COMMUNICATION FAILURE	PLEASE CONTACT WITH AFTER-SALE SERVICES
ERR8	REAR CONTROLLER FAILURE	PLEASE CONTACT WITH AFTER-SALE SERVICES
ERR9	FRONT MOTOR'S HALL FAILURE	PLEASE CONTACT WITH AFTER-SALE SERVICES

COMMON ISSUES AND SOLUTIONS

ISSUE 1: LIGHT AND HORN NOT WORKING

BOTH THE LIGHT AND HORN ARE NOT FUNCTIONING. THIS ISSUE TYPICALLY OCCURS WHEN THE DISPLAY IS DEFECTIVE AND CAN BE RESOLVED BY REPLACING THE DISPLAY.

ISSUE 2: SCOOTER NOT CHARGING

THE SCOOTER IS NOT CHARGING. THE PROBLEM COULD BE WITH THE CHARGING PORT. IF THE CHARGING PORT IS BURNED OUT, IT WILL NEED TO BE REPLACED. ANOTHER POSSIBILITY IS THAT THE CHARGER ITSELF IS DAMAGED. IN EITHER CASE, PLEASE CONTACT CUSTOMER SERVICE VIA EMAIL TO RECEIVE A SOLUTION.

ISSUE 3: ABNORMAL SOUNDS FROM BRAKE PADS

THE BRAKE PADS ARE PRODUCING ABNORMAL SOUNDS. THIS IS USUALLY CAUSED BY MISALIGNMENT. PLEASE USE THE TOOL KIT TO ADJUST THE PADS TO THE CORRECT POSITION.

MAINTENANCE & FAQ

THE SCREWS SHOULD BE REGULARLY MAINTAINED, INSPECTED AND TIGHTENED. ESPECIALLY THE SCREWS ON THE FOLDING MECHANISM, BRAKE SYSTEM AND MOTORS (AXLE NUTS).

1. TIGHTEN THE FOLDING MECHANISM SCREWS, HANDLEBAR, FRONT & REAR SHOCK ABSORBERS, FRONT & REAR WHEEL AXLE NUTS.

2. BRAKES: IF YOU FIND RUST OR EXCESSIVE WEAR ON THE BRAKES, WHICH WILL OCCUR WITH REGULAR USE OVER TIME, THE BRAKE PADS AND BRAKE DISCS SHOULD BE REPLACED.

3. MOTOR: CHECK THE MOTOR WIRES REGULARLY. ALL EXPOSED WIRES SHOULD BE WRAPPED WITH ELECTRICAL TAPE.

4. TIRES:

(1) DO NOT INFLATE THE TIRES BEYOND THE RECOMMENDED AIR PRESSURE RANGE.

(2) THE TIRES WILL SLIDE EASILY IN WET CONDITIONS. AVOID RAIN, SNOW, ICY ROAD, WET DIRT ROAD, WATER, POOR VISIBILITY.

(3) REPLACE THE TIRES ON YOUR SCOOTER ONCE WEAR PATTERNS BECOME EVIDENT. THIS WILL PROLONG THE USE OF THE SCOOTER.

5. BATTERY & OVERHEAT PROTECTION: THE CONTROLLERS AND THE BATTERY HAS TEMPERATURE SENSORS AND THE SCOOTER STOPS WORKING WHEN IT GETS TOO HOT. PLEASE WAIT ABOUT 0.5-2 HOURS TO COOL DOWN THE SCOOTER OR USE _X0003_ECO/1ST GEAR TO CONTINUE RIDING AFTER 5-10 MINUTES.

6. ADJUSTABLE SPEED LIMIT: PLEASE GO TO P8 AND THEN PRESS BOTH THE "+" AND "-" BUTTON FOR 1 MINUTE UNTIL YOU GO BACK TO THE MAIN MENU.

CUSTOMER SUPPORT

SCOOTERS MANUFACTURED BY NANROBOT ARE PRE-ASSEMBLED, THOUGH SOME OF THE PARTS MAY REQUIRE ASSEMBLY BY OUR CUSTOMERS. TO HELP ENSURE THE SAFETY OF YOUR SCOOTER AND DRIVING, PLEASE CHECK AND TEST EVERYTHING BEFORE USING YOUR SCOOTER. IF YOU FIND ANY ISSUES WITH THE SCOOTER, PLEASE CONTACT THE SELLER. YOU CAN ALSO CONTACT YOUR SELLER IF YOU NEED ASSISTANCE WITH ANY OF THE ASSEMBLY STEPS.

SHIPPING

TO PREVENT DAMAGE DURING TRANSPORTATION, WE HAVE SECURELY PACKAGED ALL ELECTRIC SCOOTER PARTS WITH FOAM AND CARDBOARD. IF ANY PARTS ARE DAMAGED UPON ARRIVAL, PLEASE TAKE PHOTOS OF THE DAMAGED COMPONENTS AND CONTACT THE SELLER. THEY WILL PROVIDE YOU WITH THE OPTIMAL SOLUTION.

MECHANICAL DAMAGE OR MODIFICATIONS

IF YOUR SCOOTER IS DAMAGED DUE TO AN ACCIDENT OR MISUSE, YOU HAVE THE OPTION TO PURCHASE REPLACEMENT PARTS FROM WWW.NANROBOT.COM, THE DISTRIBUTOR OR SELLER YOU MADE YOUR PURCHASE FROM, OR YOU CAN SEND THE SCOOTER FOR REPAIRS. PLEASE NOTE THAT THE BUYER IS RESPONSIBLE FOR ALL REPAIR COSTS.

IF YOU HAVE ANY OTHER AFTER-SALE PROBLEMS OR QUESTIONS, PLEASE FEEL FREE TO CONTACT US VIA EMAIL AT SUPPORT@NANROBOT.COM.

WARRANTY GUARANTEE

IF YOU ENCOUNTER ANY QUALITY ISSUES WITH OUR PRODUCTS, WE ARE COMMITTED TO PROVIDING YOU WITH WARRANTY COVERAGE AND EXCELLENT CUSTOMER SERVICE. YOU CAN EASILY REACH OUT TO US, AND WE WILL PROMPTLY OFFER PROFESSIONAL GUIDANCE AND EFFECTIVE SOLUTIONS. OUR WARRANTY COVERS THE ENTIRE SCOOTER, INCLUDING VULNERABLE PARTS SUCH AS TIRES, BRAKE DISCS, HORNS, DASHBOARDS, AND HEADLIGHTS. THE WARRANTY PERIOD FOR BATTERIES AND CONTROLLERS IS 180 DAYS, WHILE THE FRAME HAS A REPAIR WARRANTY PERIOD OF 365 DAYS. IN CASE OF ANY NON-HUMAN FACTORS CAUSING PROBLEMS, WE WILL PROVIDE FREE REPLACEMENT PARTS. HOWEVER, PLEASE NOTE THAT WE CANNOT BE HELD RESPONSIBLE FOR LOSSES RESULTING FROM INCORRECT RETURNS AND REFUNDS. THE BUYER IS REQUIRED TO BEAR MORE THAN 20% OF THE RETURN COST AND ROUND-TRIP TRANSPORTATION COSTS.

EXCHANGE POLICY (IF APPLICABLE)

WE GLADLY OFFER EXCHANGES FOR DEFECTIVE OR DAMAGED GOODS. HOWEVER, PLEASE NOTE THAT WE DO NOT ACCEPT RETURNS. IF YOU HAVE ANY FURTHER INQUIRIES, PLEASE FEEL FREE TO EMAIL US AT [SUPPORT@NANROBOT.COM](mailto:support@nanrobot.com).

